

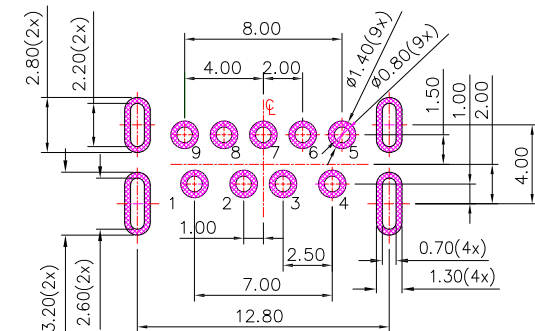

SUA-110V6-32x-S277

鍍層厚度:

Blank : 1u"
2 : 15u"
3 : 30u"

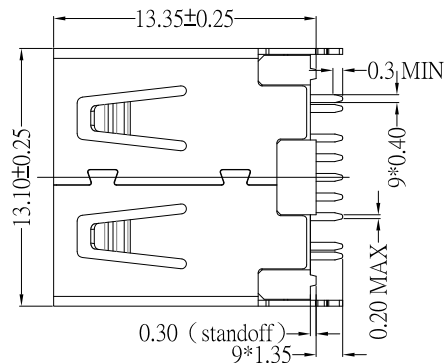

P.C.B LAYOUT MOUNTING PATTERN

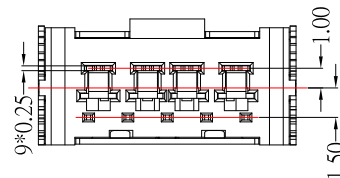
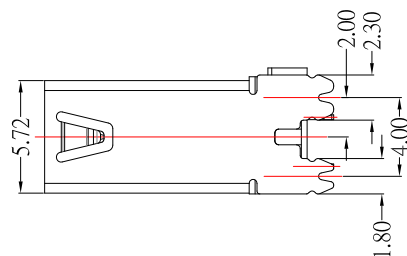
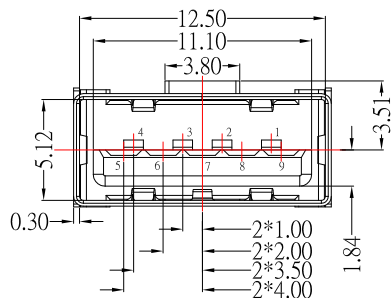

Contact Number	Signal Name
PIN1	VBUS
PIN2	D-
PIN3	D+
PIN4	GND
PIN5	StdA_SSRX-
PIN6	StdA_SSRX+
PIN7	GND_DRAIN
PIN8	StdA_SSTX-
PIN9	StdA_SSTX+
Shell	Shield

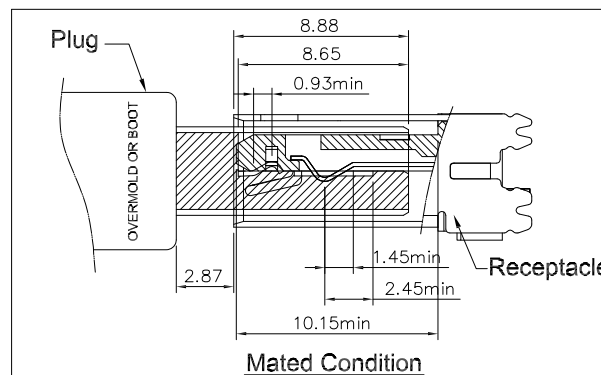
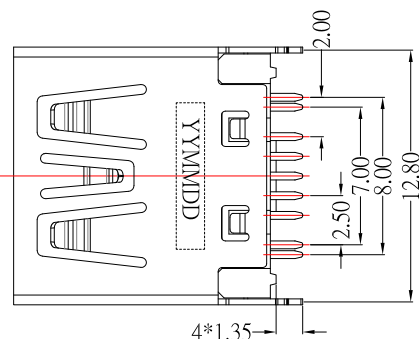
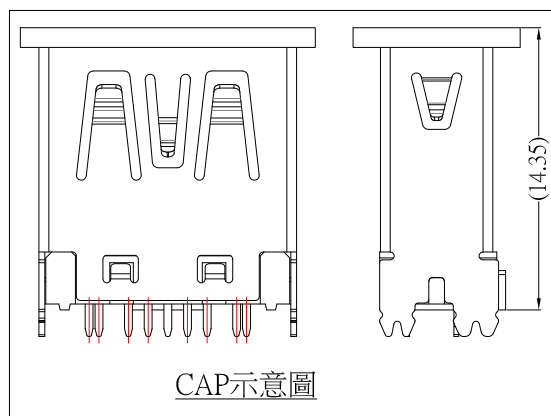

1.MATERIAL:

- 1.1 HOUSING: LCP
- 1.2 CONTACT: PHOSPHOR BRONZE
- 1.3 SHELL: SUS

2.PLATING :

- 2.1 CONTACT : Plated Gold in Mating Area ;
Tin Plated on Solder Balls ;
Nickel under plated overall
- 2.2 SHELL: Nickel under Plated surface layer

東莞市高迪電子有限公司
DONG GUAN GAO DI ELECTRONICS CO., LTD

TOLERANCE UNLESS OTHERWISE STATED :

Up to 5 ±0.2
Above 5 ~ 15 ±0.3
Above 15 ~ 30 ±0.4
Above 30 ~ 50 ±0.5
Angle ±0.3°

3RD. ANGEL'S



UNITS MM

DRAWN BY: Jack Lu
CHECKED BY: Jacky Chen
APPROVED BY: Tony Kao

DATE: 02/14/23
DATE: 02/14/23
DATE: 02/14/23

MAT'L
FINISH
SCALE: 1 : 1
SHEET NO. 1 of 1

TITLE: CONNECTOR
MODLE: USB A/F 180度 魚叉腳 無捲邊H:13.35mm GEN 2
DWG NO. SUA-110V6-32x-S277
PART NO. SUA-110V6-32x-S277

SIZE: A4
VER: R

ITEM NO.	DESCRIPTION	DRAWN	DATE